



Adapter for lances	225
Create your individual Suttner spray gun	220
Create your individual Suttner vented handle	221
easyfarm365+	197
easywash365+ handles by Suttner	217
easywash365+ lance swivels ST-345 by Suttner	217
easywash365+ spray guns by Suttner	214
Gun exit connections	222
Gun extensions	224
Half lance exit connections	223
Half-shell kits: Makeover of your gun	219
High pressure spray guns	218
Insulations for lances	225
kommunal365+	212
Longcast lances	213
Low pressure pre-spraying unit	218
R+M EcoLine No. ONE	201
ST-2750 - the lightweight among the 500 bar spray guns	210
ST-3500 high-flow spray guns	212
ST-540 foot valves	218
ST-550 foot valves	218
Suttner 500 bar ultra high pressure guns	209
Suttner 600 bar ultra high pressure guns	207-208
Suttner foam guns	203, 205-206
Suttner high pressure spray guns	188-216
Suttner high pressure spray guns for self-service car wash	215
Suttner spray guns	204
Suttner steam guns	202
Wall mount	205, 223

Suttner high pressure spray guns



Spray gun:	ST-860D	ST-4000	ST-1200	ST-1200	ST-3225	ST-3225	ST-3100	ST-2725
Max. pressure	20 bar	20 bar	24 bar	24 bar	24,5 bar	60 bar	60 bar	80 bar
Max. flow	30 l/min	50 l/min	100 l/min	100 l/min	120 l/min	120 l/min	100 l/min	80 l/min
Max. temperature	200 °C	200 °C	50 °C	50 °C	100 °C	100 °C	150 °C	150 °C
Inlet	front	front	rear	rear	linear	linear	rear	rear
Swivel at inlet	-	-	-	-	■	■	□	□
Chemical resistance	very high	-	-	-	high	high	high	high
Freeze stop version	-	-	-	-	-	-	-	-
Weep version	-	□	-	-	-	-	-	-
LTF technology	-	-	-	-	■	■	-	■
Material valve housing	brass	aluminium	brass	stainless steel	stainless steel	stainless steel	stainless steel	stainless steel
Material valve	special material	PEEK / stainless steel	brass / stainless steel	stainless steel	PEEK / stainless steel	PEEK / stainless steel	PEEK / stainless steel	PEEK / stainless steel
Food safe	-	-	-	-	■	■	■	■
One-piece valve kit	-	-	-	-	-	-	-	-
Quick coupling ☺	-	-	-	-	□	□	□	□
Quick coupling ☹	-	-	-	-	-	-	-	-
Progressive closing	-	-	-	-	□	□	■	■
Private label	□	□	-	-	□	□	□	□
Swivel at outlet	-	-	-	-	-	-	-	-
Catalogue page	19 / 202	19 / 202	16	16	203	203	206	205



Spray gun:	ST-2720	ST-810 ND	ST-3300	kommunal365+	ST-810 HD	ST-860	ST-1100	R+M EcoLine ONE
Max. pressure	125 bar	140 bar	150 bar	150 bar	210 bar	210 bar	250 bar	250 bar
Max. flow	80 l/min	30 l/min	100 l/min	80 l/min	30 l/min	30 l/min	30 l/min	45 l/min
Max. temperature	150 °C	80 °C	150 °C	150 °C	150 °C	100 °C	150 °C	150 °C
Inlet	rear	front	rear	rear	front	front	rear	rear
Swivel at inlet	□	-	□	□	-	-	□	-
Chemical resistance	high	high	high	-	-	high	-	-
Freeze stop version	-	-	-	-	-	-	-	-
Weep version	-	-	-	-	-	-	□	-
LTF technology	■	-	-	-	-	-	-	-
Material valve housing	stainless steel	brass	stainless steel	brass	brass	brass	brass	brass
Material valve	PEEK / stainless steel	POM / stainless steel	stainless steel	brass / stainless steel	stainless steel	PEEK / stainless steel	brass / stainless steel	brass / stainless steel
Food safe	-	-	■	-	-	-	-	-
One-piece valve kit	-	-	-	-	-	-	-	■
Quick coupling ☺	□	-	□	-	-	-	□	□
Quick coupling ☹	-	-	-	-	-	-	-	-
Progressive closing	-	-	-	-	-	-	-	-
Private label	□	-	-	□	-	□	-	-
Swivel at outlet	-	-	-	-	-	-	-	-
Catalogue page	204 / 205	17	206	212	198	17 / 198	199 / 215	201

Symbols ■ standard □ optional ☺ outlet ☹ inlet

Suttner high pressure spray guns



Spray gun:	easyfarm365+	ST-1500	ST-2000	ST-601	ST-3500	easywash365+	ST-2300	ST-2600
Max. pressure	250 bar	275 bar	275 bar	275 bar	350 bar	310 bar	310 bar	310 bar
Max. flow	60 l/min	45 l/min	45 l/min	45 l/min	200 l/min	45 l/min	45 l/min	45 l/min
Max. temperature	150 °C	150 °C	150 °C	150 °C	150 °C	150 °C	150 °C	150 °C
Inlet	rear	rear	rear	linear	rear	rear	rear	rear
Swivel at inlet	<input type="checkbox"/>	<input type="checkbox"/>	<input type="checkbox"/>	-	<input type="checkbox"/>	<input checked="" type="checkbox"/>	<input type="checkbox"/>	<input type="checkbox"/>
Chemical resistance	high	<input type="checkbox"/>	<input type="checkbox"/>	<input type="checkbox"/>	-	-	-	-
Freeze stop version	-	<input type="checkbox"/>	-	-	-	<input type="checkbox"/>	<input type="checkbox"/>	<input type="checkbox"/>
Weep version	-	<input type="checkbox"/>	-	-	-	<input type="checkbox"/>	<input type="checkbox"/>	<input type="checkbox"/>
LTF technology	<input checked="" type="checkbox"/>	-	-	-	<input checked="" type="checkbox"/>	<input checked="" type="checkbox"/>	-	<input checked="" type="checkbox"/>
Material valve housing	brass	brass	brass	brass	stainless steel	brass	brass	brass
Material valve	PEEK / stainless steel	brass / stainless steel	brass / stainless steel	brass / stainless steel	stainless steel	brass / stainless steel	brass / stainless steel	brass / stainless steel
Food safe	-	-	-	-	-	-	-	-
One-piece valve kit	-	<input checked="" type="checkbox"/>	<input checked="" type="checkbox"/>	-	-	<input checked="" type="checkbox"/>	<input checked="" type="checkbox"/>	<input checked="" type="checkbox"/>
Quick coupling	<input checked="" type="checkbox"/>	<input type="checkbox"/>	<input type="checkbox"/>	-	-	<input type="checkbox"/>	<input type="checkbox"/>	<input type="checkbox"/>
Quick coupling	-	-	-	-	-	-	-	<input type="checkbox"/>
Progressive closing	-	-	-	-	-	-	-	-
Private label	<input type="checkbox"/>	-	-	-	<input type="checkbox"/>	-	<input type="checkbox"/>	<input type="checkbox"/>
Swivel at outlet	-	-	-	-	-	<input type="checkbox"/>	<input type="checkbox"/>	<input type="checkbox"/>
Catalogue page	197	200 / 216	211	216	212	214	191 / 193-194 / 215	191 / 193-194 / 215



Spray gun:	ST-2700	ST-2315	ST-2605	ST-2615	ST-2635	ST-2715	ST-2750	ST-3600
Max. pressure	310 bar	350 bar	350 bar	350 bar	400 bar	350 bar	500 bar	600 bar
Max. flow	45 l/min	45 l/min	45 l/min	45 l/min	35 l/min	45 l/min	30 l/min	80 l/min
Max. temperature	150 °C	150 °C	150 °C	150 °C	150 °C	150 °C	150 °C	150 °C
Inlet	rear	rear	rear	rear	rear	rear	rear	rear
Swivel at inlet	<input type="checkbox"/>	<input type="checkbox"/>	<input type="checkbox"/>	<input type="checkbox"/>	<input checked="" type="checkbox"/>	-	<input type="checkbox"/>	<input type="checkbox"/>
Chemical resistance	-	high	-	high	-	high	-	-
Freeze stop version	-	-	-	-	-	-	-	-
Weep version	-	-	-	-	-	-	-	-
LTF technology	<input checked="" type="checkbox"/>	-	<input checked="" type="checkbox"/>	<input checked="" type="checkbox"/>	<input checked="" type="checkbox"/>	<input checked="" type="checkbox"/>	<input checked="" type="checkbox"/>	-
Material valve housing	stainless steel	brass	brass	brass	brass	stainless steel	stainless steel	stainless steel
Material valve	stainless steel	stainless steel / ceramic	brass / stainless steel	ceramic / stainless steel	carbide / stainless steel	ceramic / stainless steel	stainless steel / carbide	stainless steel
Food safe	<input checked="" type="checkbox"/>	-	-	-	-	<input checked="" type="checkbox"/>	-	-
One-piece valve kit	<input type="checkbox"/>	<input checked="" type="checkbox"/>	<input checked="" type="checkbox"/>	<input checked="" type="checkbox"/>	<input checked="" type="checkbox"/>	<input checked="" type="checkbox"/>	<input checked="" type="checkbox"/>	<input type="checkbox"/>
Quick coupling	<input type="checkbox"/>	<input type="checkbox"/>	<input type="checkbox"/>	<input type="checkbox"/>	<input type="checkbox"/>	-	-	<input type="checkbox"/>
Quick coupling	-	-	-	-	-	-	-	-
Progressive closing	-	-	-	-	-	-	-	-
Private label	<input type="checkbox"/>	<input type="checkbox"/>	<input type="checkbox"/>	<input type="checkbox"/>	<input type="checkbox"/>	<input type="checkbox"/>	<input type="checkbox"/>	<input type="checkbox"/>
Swivel at outlet	-	-	-	-	-	-	-	-
Catalogue page	203-204	196	196	196	197	204	210	207 / 208-209

Suttner high pressure spray guns

ST-2300



Professional gun.
Max. 310 bar / 45 l/min / 150 °C

R+M Nr.	☺	☻
202 300 500	1/4" F	3/8" F



Professional gun.
Max. 310 bar / 45 l/min / 150 °C

R+M Nr.	☺	☻
202 300 550	1/4" F	3/8" F swivel



Professional gun.
Max. 310 bar / 45 l/min / 150 °C

R+M Nr.	☺	☻
202 300 520	1/4" F	M22 M



Professional gun.
Max. 310 bar / 45 l/min / 150 °C

R+M Nr.	☺	☻
202 300 553	1/4" F	M22 M swivel



Professional gun.
Max. 310 bar / 45 l/min / 150 °C

R+M Nr.	☺	☻
202 300 730	M21 M	M21 M



Professional gun.
Max. 310 bar / 45 l/min / 150 °C

R+M Nr.	☺	☻
202 300 760	M22 F	M22 M



Professional gun with insulated outlet suitable for lances with swivel screw coupling.
Max. 310 bar / 45 l/min / 150 °C

R+M Nr.	☺	☻
202 300 710	M22 M	M22 M



Professional gun with insulated outlet suitable for lances with swivel screw coupling.
Max. 310 bar / 45 l/min / 150 °C

R+M Nr.	☺	☻
202 300 720	M22 M	M22 M swivel



Professional gun with lance swivel ST-345.
Max. 310 bar / 45 l/min / 150 °C

R+M Nr.	☺	☻
202 300 801	1/4" F swivel	3/8" F swivel



Professional gun with Variopress. Variopress regulates the water quantity and serves for the adjustment of pressure.
Max. 310 bar / 45 l/min / 150 °C

R+M Nr.	☺	☻
202 300 810	1/4" F	3/8" F



Professional gun with Variopress. Variopress regulates the water quantity and serves for the adjustment of pressure.
Max. 310 bar / 45 l/min / 150 °C

R+M Nr.	☺	☻
202 300 830	M22 M	M22 M swivel



Professional gun with Variopress and coupling KW. Variopress regulates the water quantity and serves for the adjustment of pressure.
Max. 310 bar / 45 l/min / 150 °C

R+M Nr.	☺	☻
202 300 631	coupling KW	3/8" F

Symbols ☺ outlet ☻ inlet

Suttner high pressure spray guns

ST-2600



LTF

Professional gun with patented LTF technology.
Max. 310 bar / 45 l/min / 150 °C

R+M Nr.		
202 600 500	1/4" F	3/8" F



LTF

Professional gun with patented LTF technology.
Max. 310 bar / 45 l/min / 150 °C

R+M Nr.		
202 600 550	1/4" F	3/8" F swivel



LTF

Professional gun with patented LTF technology.
Max. 310 bar / 45 l/min / 150 °C

R+M Nr.		
202 600 520	1/4" F	M22 M



LTF

Professional gun with patented LTF technology.
Max. 310 bar / 45 l/min / 150 °C

R+M Nr.		
202 600 553	1/4" F	M22 M swivel



LTF

Professional gun with patented LTF technology.
Max. 310 bar / 45 l/min / 150 °C

R+M Nr.		
202 600 730	M21 M	M21 M



LTF

Professional gun with patented LTF technology.
Max. 310 bar / 45 l/min / 150 °C

R+M Nr.		
202 600 760	M22 F	M22 M



LTF

Professional gun with patented LTF technology and insulated outlet suitable for lances with swivel screw coupling.
Max. 310 bar / 45 l/min / 150 °C

R+M Nr.		
202 600 710	M22 M	M22 M



LTF

Professional gun with patented LTF technology and insulated outlet suitable for lances with swivel screw coupling.
Max. 310 bar / 45 l/min / 150 °C

R+M Nr.		
202 600 720	M22 M	M22 M swivel



LTF

Professional gun with lance swivel ST-345.
Max. 310 bar / 45 l/min / 150 °C

R+M Nr.		
202 600 801	1/4" F swivel	3/8" F swivel



LTF

Professional gun with patented LTF technology and Variopress. Variopress regulates the water quantity and serves for the adjustment of pressure. Max. 310 bar / 45 l/min / 150 °C

R+M Nr.		
202 600 810	1/4" F	3/8" F



LTF

Professional gun with patented LTF technology and Variopress. Variopress regulates the water quantity and serves for the adjustment of pressure. Max. 310 bar / 45 l/min / 150 °C

R+M Nr.		
202 600 830	M22 M	M22 M swivel



LTF

Pro gun with patented LTF technology and Variopress and coupling KW. Variopress regulates the water quantity and serves for the adjustment of pressure. Max. 310 bar / 45 l/min / 150 °C

R+M Nr.		
202 600 632	coupling KW	3/8" F swivel

Suttner high pressure spray guns

ST-2300



A

Professional gun with coupling KW.
Max. 310 bar / 45 l/min / 150 °C

R+M Nr.	☺	☹
202 300 560	coupling KW	3/8" F



G

Professional gun with extension ST-9.1 260 mm and coupling KW. Max. 310 bar / 45 l/min / 150 °C

R+M Nr.	☺	☹
202 300 681	coupling KW	3/8" F



A

Professional gun with coupling KW.
Max. 310 bar / 45 l/min / 150 °C

R+M Nr.	☺	☹
202 300 570	coupling KW	3/8" F swivel



G

Professional gun with extension ST-9.1 260 mm and coupling KW. Max. 310 bar / 45 l/min / 150 °C

R+M Nr.	☺	☹
202 300 682	coupling KW	3/8" F swivel



Kr

Professional gun with coupling KW.
Max. 310 bar / 45 l/min / 150 °C

R+M Nr.	☺	☹
202 300 605	coupling KW	M22 M swivel



Kr

Professional gun with extension ST-9.1 260 mm and coupling KW. Max. 310 bar / 45 l/min / 150 °C

R+M Nr.	☺	☹
202 300 684	coupling KW	M22 M

Coupling KW



Spare coupling for ST-2300 / ST-2600 with coupling KW

R+M Nr.
202 300 301

Spare coupling for ST-2300 with coupling KW

R+M Nr.
202 300 306

Plug KW



Plug KW : 1/4" F

R+M Nr.
040 001 255

O-ring



O-ring for coupling KW

R+M Nr.
050 000 248

Lip seals



Tool for assembly of lip seal

R+M Nr.
202 300 365



Lip seal for coupling KW

R+M Nr.
050 000 249

Symbols ☺ outlet ☹ inlet

Suttner high pressure spray guns

ST-2600



LTF

G

Professional gun with patented LTF technology. Gun with extension ST-9.1 260 mm and coupling KW. Max. 310 bar / 45 l/min / 150 °C

R+M Nr.	☺	☺
202 600 581	coupling KW	3/8" F



LTF

A

Professional gun with patented LTF technology and coupling KW. Max. 310 bar / 45 l/min / 150 °C

R+M Nr.	☺	☺
202 600 540	coupling KW	3/8" F



LTF

G

Professional gun with patented LTF technology. Gun with extension ST-9.1 260 mm and coupling KW. Max. 310 bar / 45 l/min / 150 °C

R+M Nr.	☺	☺
202 600 582	coupling KW	3/8" F swivel



LTF

A

Professional gun with patented LTF technology and coupling KW. Max. 310 bar / 45 l/min / 150 °C

R+M Nr.	☺	☺
202 600 545	coupling KW	3/8" F swivel



LTF

Kr

Professional gun with patented LTF technology. Gun with extension ST-9.1 260 mm and coupling KW. Max. 310 bar / 45 l/min / 150 °C

R+M Nr.	☺	☺
202 600 684	coupling KW	M22 M



LTF

Kr

Professional gun with patented LTF technology and coupling KW. Max. 310 bar / 45 l/min / 150 °C

R+M Nr.	☺	☺
202 600 625	coupling KW	M22 M swivel

ST-345 lance swivel

ST-345 lance swivel



1/4" F : 3/8" F

R+M Nr.
200 301 050



1/4" F : M22 M

R+M Nr.
200 301 060

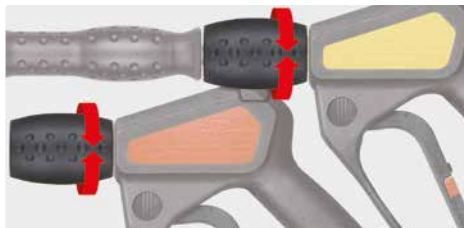

1/4" F : 1/4" M. Lance swivel for spray guns ST-2300 / ST-2600



Repair kit ST-301

R+M Nr.
200 300 100



Valves complete

ST-2300 / ST-2600

R+M Nr.
202 300 490



R+M Nr.
200 345 500

LTF - Low Trigger Force 90 % reduced holding force and 40 % reduced trigger force against usual market guns.

Suttner high pressure spray guns

ST-2300

Valves complete



202 300 860 and
202 300 701

R+M Nr.

202 300 490

IP Kr



Professional gun with extension ST-9.1 350 mm and M22 F. Max. 310 bar / 45 l/min / 150 °C

R+M Nr.		
202 300 860	M22 F	M22 M



IP Kr

Professional gun with extension ST-9.9 370 mm and M22 F. Max. 310 bar / 45 l/min / 150 °C

R+M Nr.		
202 300 701	M22 F	M22 M swivel

ST-2600

Valves complete

202 600 860 and
202 600 701



R+M Nr.

202 300 490

LTF

IP Kr

Professional gun with patented LTF technology. Gun with extension ST-9.1 350 mm and M22 F. Max. 310 bar / 45 l/min / 150 °C



R+M Nr.		
202 600 860	M22 F	M22 M



LTF

IP Kr

Professional gun with patented LTF technology. Gun with extension ST-9.9 370 mm and M22 F. Max. 310 bar / 45 l/min / 150 °C

R+M Nr.		
202 600 701	M22 F	M22 M swivel

Suttner high pressure spray guns

ST-2300

Valves complete





202 300 635 and
202 300 640

R+M Nr.
202 300 490

IPC



Professional gun with extension 340 mm and M22 F. Max. 310 bar / 45 l/min / 150 °C

R+M Nr.		
202 300 635	M22 F	M22 M



IPC

Professional gun with extension 340 mm and M22 F. Max. 310 bar / 45 l/min / 150 °C

R+M Nr.		
202 300 640	M22 F	M22 M swivel

ST-2300

Valves complete





202 300 645

R+M Nr.
202 315 490

IPC

Professional gun with extension 340 mm and M22 F. Max. 310 bar / 45 l/min / 150 °C

R+M Nr.		
202 300 645	M22 F	3/8" M

Symbols  outlet  inlet

Suttner high pressure spray guns

ST-2315



Professional gun. Ceramic ball, chemically resistant valve and acid-resistant stain. steel seal seat. Designed for applications e.g. in the prewash of vehicles.
Max. 350 bar / 45 l/min / 150 °C

R+M Nr.		
202 315 500	1/4" F	3/8" F



Professional gun. Ceramic ball, chemically resistant valve and acid-resistant stain. steel seal seat. Designed for applications e.g. in the prewash of vehicles.
Max. 350 bar / 45 l/min / 150 °C

R+M Nr.		
202 315 550	1/4" F	3/8" F swivel

ST-2600



LTF

Professional gun with patented LTF technology.
Max. 310 bar / 45 l/min / 150 °C

R+M Nr.		
202 600 560	1/4" F	3/8" F

ST-2600



new

Professional gun with patented LTF technology.
Coupling ST-247 stainless steel.
Max. 310 bar / 45 l/min / 150 °C

R+M Nr.		
202 600 747	ST-247® swivel	ST-247® swivel

ST-2605



LTF

Professional gun with patented LTF technology.
Max. 350 bar / 45 l/min / 150 °C

R+M Nr.		
202 605 500	1/4" F	3/8" F stainless steel

ST-2615



LTF

Professional gun. Ceramic ball, chemically resistant valve and acid-resistant stainless steel seal seat. Designed for applications e.g. in the prewash of vehicles.
Max. 350 bar / 45 l/min / 150 °C

R+M Nr.		
202 615 500	1/4" F	3/8" F

ST-2615



LTF

Professional gun. Ceramic ball, chemically resistant valve and acid-resistant stainless steel seal seat. Designed for applications e.g. in the prewash of vehicles.
Max. 350 bar / 45 l/min / 150 °C

R+M Nr.		
202 615 550	1/4" F	3/8" F swivel



new

LTF

Professional gun. Ceramic ball, chemically resistant valve and acid-resistant stainless steel seal seat. Designed for applications e.g. in the construction industry, road works or mining.
Max. 350 bar / 45 l/min / 150 °C

R+M Nr.		
202 615 615	1/4" F	3/8" F swivel



new

LTF

Professional gun. Ceramic ball, chemically resistant valve and acid-resistant stainless steel seal seat. Designed for applications e.g. in the construction industry, road works or mining.
Max. 350 bar / 45 l/min / 150 °C

R+M Nr.		
202 615 525	coupling KW	3/8" F swivel

Symbols outlet inlet

Suttner high pressure spray guns

ST-2635 Industrial



Professional gun. Patented valve kit. Especially wear-resistant ball made out of carbide. Swivel made out of stainless steel.
Max. 400 bar / 35 l/min / 150 °C

R+M Nr.		
202 635 550	1/4" F	3/8" F swivel



Professional gun with coupling KW. Patented valve kit. Especially wear-resistant ball made out of carbide. Swivel made out of stainless steel. Coupling KW made of stainless steel.
Max. 400 bar / 35 l/min / 150 °C

R+M Nr.		
202 635 570	coupling KW	3/8" F swivel



Professional gun with insulated outlet suitable for lances with swivel screw coupling. Patented valve kit. Especially wear-resistant ball made out of carbide. Swivel made out of stainless steel.
Max. 400 bar / 35 l/min / 150 °C

R+M Nr.		
202 635 720	M22 M	M22 M swivel

easyfarm365+



Professional gun with coupling KW.
Max. 250 bar / 60 l/min / 150 °C

R+M Nr.		
202 620 655	coupling KW	1/2" F swivel



Professional gun with coupling ST-3100.
Max. 250 bar / 60 l/min / 150 °C

R+M Nr.		
202 620 650	coupling ST-3100	1/2" F swivel

ST-340 swivel



1/4" F : 1/2" F



Repair kit ST-340

R+M Nr.
200 340 520

R+M Nr.
200 340 150

Valves complete



ST-2315, ST-2615

R+M Nr.
202 315 490



ST-2600

R+M Nr.
202 300 490



ST-2605

R+M Nr.
202 300 490



ST-2635 Industrial

R+M Nr.
202 300 492



easyfarm365+

R+M Nr.
202 620 491

ST-311 swivel



1/4" F : 3/8" F

R+M Nr.
200 311 050



1/4" F : M22 M

R+M Nr.
200 311 060



Repair kit ST-311

R+M Nr.
200 300 100

LTF - Low Trigger Force 90 % reduced holding force and 40 % reduced trigger force against usual market guns.



LTF+ - Low Trigger Force + 90 % reduced holding force and 55 % reduced trigger force against usual market guns.

Suttner high pressure spray guns

ST-810





Max. 210 bar / 30 l/min / 150 °C

R+M Nr.		
200 810 740	M22 M	M22 M



Gun with extension 340 mm and M22 F. Max. 210 bar / 30 l/min / 150 °C

R+M Nr.		
200 810 750	M22 F	M22 M

IP Kr



Max. 210 bar / 30 l/min / 150 °C

R+M Nr.		
200 810 530	1/4" F	1/4" F

ST-810



Valve complete

R+M Nr.
200 810 491

ST-860



Gun with PEEK piston.



Max. 210 bar / 30 l/min / 100 °C

R+M Nr.		
200 860 500	1/4" F	1/4" F



Gun with PEEK piston.

Max. 210 bar / 30 l/min / 100 °C

R+M Nr.		
200 860 520	M22 M	M22 M

ST-860



Valve complete

R+M Nr.
200 860 490

Symbols  outlet  inlet  length

Suttner high pressure spray guns

ST-1100



Professional gun.
Max. 210 bar / 25 l/min / 150 °C

R+M Nr.		
201 100 500	1/4" F	3/8" F



Professional gun.
Max. 210 bar / 25 l/min / 150 °C

R+M Nr.		
201 100 540	1/4" F	3/8" F swivel



Professional gun.
Max. 210 bar / 25 l/min / 150 °C

R+M Nr.		
201 100 545	M22 M	M22 M



Professional gun. Weep version.
Max. 210 bar / 25 l/min / 150 °C

R+M Nr.		
201 100 535	1/4" F	3/8" F



Professional gun. Weep version.
Max. 210 bar / 25 l/min / 150 °C

R+M Nr.		
201 100 530	1/4" F	3/8" F swivel



Professional gun ST-1100 with coupling KW.
Max. 210 bar / 25 l/min / 150 °C

R+M Nr.		
201 100 560	coupling KW	3/8" F



Professional gun without valve.
Max. 210 bar / 25 l/min / 150 °C

R+M Nr.		
201 100 570	1/4" F	3/8" F swivel



Professional gun with extension 340 mm,
max. 210 bar / 25 l/min / 150 °C.
Inlet / outlet M22 F. Hose: 6 - 160 (polyester interior), max. 160 bar / 20 °C

R+M Nr.	hose	
201 100 700	6 - 160	8 m



Professional gun with extension 340 mm,
max. 210 bar / 25 l/min / 150 °C.
Inlet / outlet M22 F. Hose: Flexy (single wire braid), max. 300 bar / 100 °C

R+M Nr.	hose	
201 100 710	Flexy	8 m



Professional gun with extension 340 mm and M22 F.
Max. 210 bar / 25 l/min / 150 °C

R+M Nr.		
201 100 522	M22 F	3/8" F



Professional gun with extension 340 mm and M22 F.
Max. 210 bar / 25 l/min / 150 °C

R+M Nr.		
201 100 523	M22 F	M22 M

Suttner high pressure spray guns

ST-1500



Professional gun.
Max. 275 bar / 45 l/min / 150 °C

R+M Nr.		
201 500 500	1/4" F	3/8" F



Professional gun.
Max. 275 bar / 45 l/min / 150 °C

R+M Nr.		
201 500 560	1/4" F	3/8" F swivel



Professional gun.
Max. 275 bar / 45 l/min / 150 °C

R+M Nr.		
201 500 550	1/4" F	M22 M



Professional gun.
Max. 275 bar / 45 l/min / 150 °C

R+M Nr.		
201 500 545	M22 M	M22 M



Professional gun.
Max. 275 bar / 45 l/min / 150 °C

R+M Nr.		
201 500 760	M22 F	M22 M



Professional gun. Freeze stop version.
Max. 275 bar / 45 l/min / 150 °C

R+M Nr.		
201 500 580	1/4" F	3/8" F



Professional gun. Freeze stop version.
Max. 275 bar / 45 l/min / 150 °C

R+M Nr.		
201 500 581	1/4" F	3/8" F swivel



Professional gun. Weep version.
Max. 275 bar / 45 l/min / 150 °C

R+M Nr.		
201 500 620	1/4" F	3/8" F



Professional gun without valve.
Max. 275 bar / 45 l/min / 150 °C

R+M Nr.		
201 500 750	1/4" F	3/8" F

ST-300 swivel



1/4" F : 3/8" F. ST-1500

R+M Nr.
200 300 050



Repair kit ST-300

R+M Nr.
200 300 100

Repair kit



ST-1100. Swivel

R+M Nr.
200 300 100

Seal kit

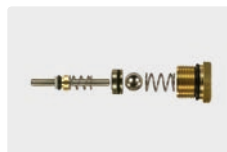

ST-1100

R+M Nr.
201 100 401

Valves complete

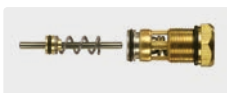

ST-1500

R+M Nr.
202 000 044



ST-1500 weep

R+M Nr.
202 000 045

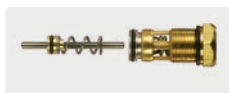

ST-1500 freeze stop

R+M Nr.
202 000 101

Symbols outlet inlet

R+M EcoLine No. ONE

R+M EcoLine No. ONE



Professional gun R+M EcoLine No. ONE.
Max. 250 bar / 45 l/min / 150 °C

R+M Nr.		
507 001 500	1/4" F	3/8" F



Professional gun R+M EcoLine No. ONE.
Max. 250 bar / 45 l/min / 150 °C

R+M Nr.		
507 001 550	1/4" F	M22 M



Professional gun R+M EcoLine No. ONE.
Max. 250 bar / 45 l/min / 150 °C

R+M Nr.		
507 001 580	M22 M	M22 M



Professional gun R+M EcoLine No. ONE.
Max. 250 bar / 45 l/min / 150 °C

R+M Nr.		
507 001 590	M22 M	10 mm



Professional gun R+M EcoLine No. ONE.
Max. 250 bar / 45 l/min / 150 °C

R+M Nr.		
507 001 591	M22 M	11 mm



Professional gun R+M EcoLine No. ONE with coupling KW. Max. 250 bar / 45 l/min / 150 °C

R+M Nr.		
507 001 560	coupling KW	3/8" F
507 001 562	coupling KW	M22 M

R+M EcoLine No. ONE ergonomic design - innovative - reliable

R+M EcoLine No. ONE



Professional gun R+M EcoLine No. ONE with lance 900 mm zinc-plated steel, insulation ST-28 Cool & Compact 300 mm and nozzle protector ST-10 without nozzle. Max. 250 bar / 45 l/min / 150 °C

R+M Nr.		
507 001 790	1/4" F NPT	3/8" F



Professional gun R+M EcoLine No. ONE with lance 900 mm zinc-plated steel, insulation ST-28 Cool & Compact 300 mm and nozzle protector without tip. Max. 250 bar / 45 l/min / 150 °C

R+M Nr.		
507 001 951	nozzle protector	M22 M

Valve complete



R+M Nr.
202 000 044

Piston rod



R+M Nr.
201 000 900

ST-300 swivel



3/8" M : 3/8" F

R+M Nr.
200 300 010



Repair kit ST-300

R+M Nr.
200 300 100

Suttner steam guns

The steam guns of the series ST-4000 and ST-860D are the ideal solution for cleaning tasks with steam. Both series are designed for a medium temperature of up to 200 °C and for a working pressure of max. 20 bar. By means of a specifically produced valve housing with 3/4" F made out of aluminium the ST-4000 is suitable for extremely high flow rates. The ST-860D is unbeatable in case of small and medium flow rates.

Apart from being enormously resistant to high temperatures the sealing copolymer is suitable for all liquids based on mineral oil as well as for inorganic acids, alkaline solutions, alcohol and anti-corrosion liquids based on amines and seawater or on their mixtures.

The fact that the hose connection is positioned in the front of the gun positively effects the professional handling with the gun as well as the heat radiation close to hand and body.

ST-860D steam gun



Professional steam gun ST-860D.
Max. 20 bar / 200 °C

R+M Nr.	↔	⊕
200 860 550	1/4" F	1/4" F

ST-860D steam gun with lance



Professional steam gun with lance stainless steel 400 mm, vented handle ST-9.1 220 mm and nozzle protector ST-12 without nozzle. Max. 20 bar / 200 °C

R+M Nr.	↔	⊕
200 860 555	nozzle protector ST-12	1/4" F

ST-4000 steam guns with lance



Professional steam gun with lance stainless steel, vented handle ST-9 380 mm and steam low pressure nozzle made out of stainless steel. Max. 20 bar / 200 °C

R+M Nr.	↔	⊕
204 000 500	500 mm	3/4" F
204 000 520	1,000 mm	3/4" F

ST-4000 steam gun weep version with lance



Professional steam gun ST-4000 weep version with lance stainless steel, vented handle ST-9 380 mm and steam low pressure nozzle made out of stainless steel. Max. 20 bar / 200 °C

R+M Nr.	↔	⊕
204 000 560	1,000 mm	3/4" F

Suttner foam guns

ST-3225 HP

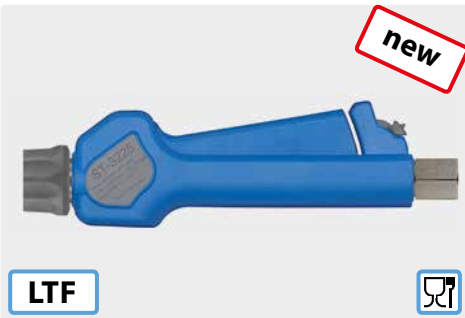

Professional hp gun with progressive closing system and coupling ST-3100. Stainless steel. Field of application: foam and rinsing applications in the food industry etc. Industry standard. Max. 60 bar / 120 l/min / 100 °C

R+M Nr.		
203 225 550	coupling ST-3100	1/2" F swivel

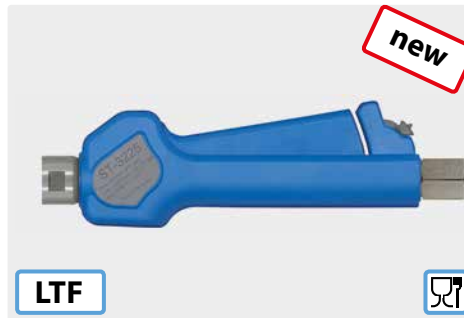

Professional hp gun with progressive closing system. Stainless steel. Field of application: foam and rinsing applications in the food industry etc. Industry standard. Max. 60 bar / 120 l/min / 100 °C

R+M Nr.		
203 225 545	1/2" F	1/2" F swivel

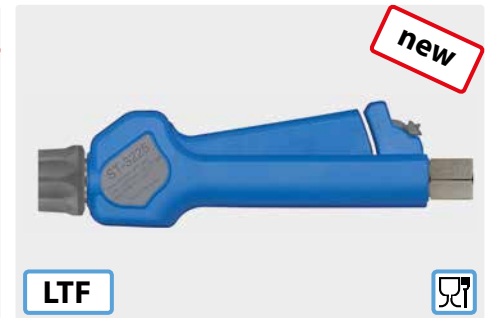

Professional hp gun with coupling ST-3100. Stainless steel. Field of application: foam and rinsing applications in the food industry etc. Industry standard. Max. 60 bar / 120 l/min / 100 °C

R+M Nr.		
203 225 540	coupling ST-3100	1/2" F swivel

ST-3225 LP

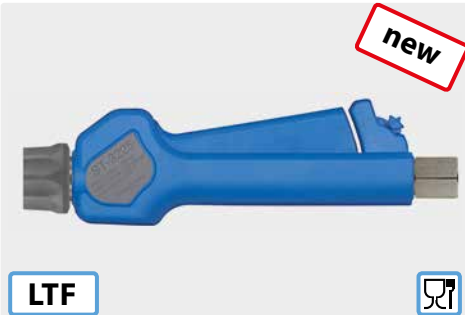

Professional gun with progressive closing system, locking in opened position and coupling ST-3100. Stainless steel. Field of application: foam and rinsing applications in the food industry etc. Industry standard. Max. 24.5 bar / 120 l/min / 100 °C

R+M Nr.		
203 225 650	coupling ST-3100	1/2" F swivel

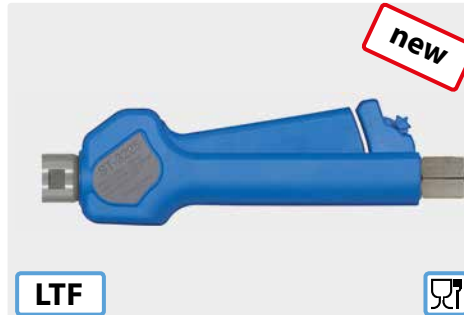

Professional gun with progressive closing system and locking in opened position. Stainless steel. Field of application: foam and rinsing applications in the food industry etc. Industry standard. Max. 24.5 bar / 120 l/min / 100 °C

R+M Nr.		
203 225 645	1/2" F	1/2" F swivel

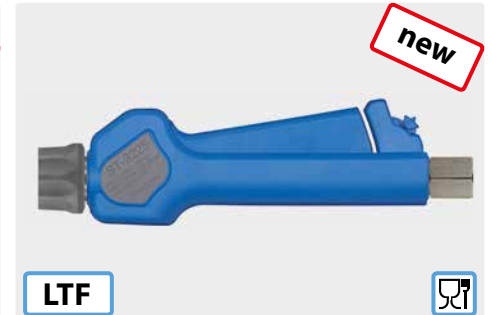

Professional gun with locking in opened position and coupling ST-3100. Stainless steel. Field of application: foam and rinsing applications in the food industry etc. Industry standard. Max. 24.5 bar / 120 l/min / 100 °C

R+M Nr.		
203 225 640	coupling ST-3100	1/2" F swivel

ST-2700 KW



Professional gun with patented LTF technology. Stainless steel. Gun with coupling KW. Max. 310 bar / 45 l/min / 150 °C

R+M Nr.		
202 700 560	coupling KW	3/8" F

ST-2700 KW



Professional gun with patented LTF technology. Stainless steel. Gun with coupling KW. Max. 310 bar / 45 l/min / 150 °C

R+M Nr.		
202 700 575	coupling KW	3/8" F swivel

ST-2700 KW



Professional gun with patented LTF technology. Stainless steel. Gun with coupling KW. Max. 310 bar / 45 l/min / 150 °C

R+M Nr.		
202 700 565	coupling KW	M22 M

Symbols outlet inlet length

Suttner spray guns

ST-2700



Professional gun with patented LTF technology. Stainless steel. Gun for industrial cleaning applications. Max. 310 bar / 45 l/min / 150 °C

R+M Nr.		
202 700 500	1/4" F	3/8" F

ST-2715



Professional gun with patented LTF technology. Stainless steel. Ceramic ball, chemically resistant valve and acid-resistant stainless steel seal seat. Gun for industrial cleaning applications with abrasive mediums. Max. 350 bar / 45 l/min / 150 °C

R+M Nr.		
202 715 500	1/4" F	3/8" F



Professional gun with patented LTF technology. Stainless steel. Ceramic ball, chemically resistant valve and acid-resistant stainless steel seal seat. Gun for industrial cleaning applications with abrasive mediums. Max. 350 bar / 45 l/min / 150 °C

R+M Nr.		
202 715 580	M22 M	M22 M swivel

ST-2720



Professional gun with patented LTF technology. Stainless steel. Particularly designed for huge water amounts. Suitable for e.g. municipal technology. Max. 125 bar / 80 l/min / 150 °C

R+M Nr.		
202 720 500	1/4" F	3/8" F



Made out of plastics intended to come into contact with food-stuffs according to Regulation (EC) No. 1935/2004. Especially designed for applications in the food industry.



Valves complete



ST-2700

R+M Nr.
202 700 490



ST-2715. Ceramic ball

R+M Nr.
202 700 445



ST-2720

R+M Nr.
202 710 490



ST-2725

R+M Nr.
202 725 490

ST-340 swivel



1/4" F : 1/2" F

R+M Nr.
200 340 050



Repair kit ST-340

R+M Nr.
200 340 100

LTF - Low Trigger Force 90 % reduced holding force and 40 % reduced trigger force against usual market guns.

Symbols outlet inlet

Suttner foam guns

ST-2725 with coupling ST-3100



Pro gun with patented LTF technology and progressive closing system. Gun with coupling ST-3100. Field of application: foam and rinsing applications in the food industry etc. Stainless steel. Chemically resistant valve piston stainless steel. PEEK piston. Max. 80 bar / 80 l/min / 150 °C

R+M Nr.		
202 725 550	coupling ST-3100	1/2" F swivel

ST-2725



Pro gun with patented LTF technology and progressive closing system. Field of application: foam and rinsing applications in the food industry etc. Stainless steel. Chemically resistant valve piston stainless steel. PEEK piston. Max. 80 bar / 80 l/min / 150 °C

R+M Nr.		
202 725 535	1/2" F	1/2" F swivel

ST-2720



Professional gun with patented LTF technology. Stainless steel. Suitable for e.g. huge water amounts in the food industry. PEEK valve cone enables use in low pressure. Max. 125 bar / 80 l/min / 150 °C

R+M Nr.		
202 720 530	3/8" F	1/2" F

ST-2720 with coupling ST-3100



Professional gun with patented LTF technology. Gun with coupling ST-3100. Stainless steel. Suitable for e.g. huge water amounts in the food industry. PEEK valve cone enables use in low pressure. Max. 125 bar / 80 l/min / 150 °C

R+M Nr.		
202 720 550	coupling ST-3100	1/2" F swivel

ST-2620



Professional gun with patented LTF technology. Gun with insulated stainless steel lance 300 mm and nozzle 50° 200. Gun brass. Lance stainless steel. Field of application: foam applications in the prewash of vehicles etc. Max. 125 bar / 80 l/min / 150 °C

R+M Nr.		
202 620 910	nozzle 50° 200	1/2" F swivel

Wall mount



Stainless steel. Wall mount for Suttner high pressure guns with lance or twin lance

R+M Nr.
040 002 055



Made out of plastics intended to come into contact with foodstuffs according to Regulation (EC) No. 1935/2004. Especially designed for applications in the food industry.



LTF - Low Trigger Force 90 % reduced holding force and 40 % reduced trigger force against usual market guns.

Suttner foam guns

ST-3100



Professional gun with progressive closing system. Gun with coupling ST-3100. Stainless steel. Field of application: foam and rinsing applications in the food industry etc. Industry standard. Max. 60 bar / 100 l/min / 150 °C

R+M Nr.		
203 100 805	coupling ST-3100	1/2" F swivel



Professional gun with progressive closing system. Stainless steel. Field of application: foam and rinsing applications in the food industry etc. Industry standard. Max. 60 bar / 100 l/min / 150 °C

R+M Nr.		
203 100 840	3/8" F	1/2" F



Professional gun with progressive closing system. Gun with coupling ST-3100. Stainless steel. Field of application: foam and rinsing applications in the food industry etc. Industry standard. Max. 60 bar / 100 l/min / 150 °C

R+M Nr.		
203 100 810	coupling ST-3100	1/2" F

ST-3100



Professional gun with progressive closing system. Gun with coupling ST-3100. Stainless steel. Field of application: foam and rinsing applications in the food industry etc. Industry standard. Max. 60 bar / 100 l/min / 150 °C

R+M Nr.		
203 100 820	coupling ST-3100	1/2" F

ST-340



1/2" M : 1/2" F

R+M Nr.
200 340 010



Repair kit ST-340

R+M Nr.
200 340 100

ST-3100



Seal kit

R+M Nr.
203 100 400

ST-3300



Seal kit

R+M Nr.
203 300 490

ST-3300



Professional high-flow gun. Gun with coupling ST-45. Stainless steel. Field of application: foam and rinsing applications in the food industry etc. Max. 150 bar / 100 l/min / 150 °C

R+M Nr.		
203 300 500	coupling ST-45	1/2" F



Professional high-flow gun. Stainless steel. Field of application: foam and rinsing applications in the food industry etc. Max. 150 bar / 100 l/min / 150 °C

R+M Nr.		
203 300 510	1/2" F	1/2" F

Symbols outlet inlet length

Suttner 600 bar ultra high pressure guns

ST-3600



Professional ultra high pressure gun.
Max. 600 bar / 80 l/min / 150 °C

R+M Nr.		
203 600 545	1/4" F	1/2" F



Professional ultra high pressure gun.
Max. 600 bar / 80 l/min / 150 °C

R+M Nr.		
203 600 550	1/2" F	1/2" F



Professional ultra high pressure gun.
Max. 600 bar / 80 l/min / 150 °C

R+M Nr.		
203 600 570	1/2" F	1/2" F swivel



Professional ultra high pressure gun with coupling ST-45. Max. 600 bar / 80 l/min / 150 °C

R+M Nr.		
203 600 655	coupling ST-45	3/8" F



Professional ultra high pressure gun with coupling ST-45. Max. 600 bar / 80 l/min / 150 °C

R+M Nr.		
203 600 650	coupling ST-45	1/2" F



ST-3900 shoulder supports. New European Union guidelines imperatively prescribe the use of shoulder supports for cleaning applications exceeding an operating reaction force of 150 N. Variably adjustable ST-3900. Swiveling coupling. Suitable for guns ST-3600 / ST-3500.

R+M Nr.	telescope		
203 900 500	340 - 500 mm	505 - 675 mm	

ST-351 swivel



1/2" M : 1/2" F.
Max. 600 bar

R+M Nr.
200 351 510



Repair kit swivel ST-351

R+M Nr.
200 351 400

Seal kits ST-740



O-ring

R+M Nr.
050 000 408



Back ring

R+M Nr.
050 000 407

Seal kits ST-3600

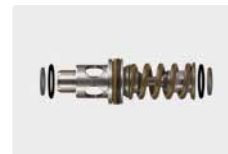



R+M Nr.
203 600 490

Suttner 600 bar ultra high pressure guns

ST-3600



Professional ultra high pressure gun with extension ST-9.1 380 mm and quick screw coupling ST-740. Max. 600 bar / 80 l/min / 150 °C

R+M Nr.		
203 600 532	M24 F	M24 M swivel



Professional ultra high pressure gun with extension ST-9 380 mm, grip and M22 M. Max. 500 bar / 80 l/min / 150 °C

R+M Nr.		
203 600 530	M24 F	M24 M

Ultra high pressure lances



M24 M. Lance 400 mm with nozzle protector ST-10 without nozzle. Lance for ultra high pressure guns with extension ST-9. Max. 600 bar / 150 °C

R+M Nr.		
203 600 470	1/4" F NPT	M24 M

Symbols  outlet  inlet  length

Suttner 500 bar ultra high pressure guns

ST-3600



F

Professional ultra high pressure gun.
Max. 500 bar / 80 l/min / 150 °C

R+M Nr.	☺	☻
203 600 556	M22 F	M22 M



Professional ultra high pressure gun.
Max. 500 bar / 80 l/min / 150 °C

R+M Nr.	☺	☻
203 600 555	1/4" F	M22 M



ST-3900 shoulder supports. New European Union guidelines imperatively prescribe the use of shoulder supports for cleaning applications exceeding an operating reaction force of 150 N. Variably adjustable ST-3900. Swiveling coupling. Suitable for guns ST-3600 / ST-3500.

R+M Nr.	telescope ☺	☻
203 900 500	340 - 500 mm	505 - 675 mm



Professional ultra high pressure gun with extension ST-9 380 mm, grip and M22 F. Max. 500 bar / 80 l/min / 150 °C

R+M Nr.	☺	☻
203 600 535	M22 F	M22 M

Ultra high pressure lance



M22 M. Lance 335 mm with nozzle protector ST-10 without nozzle. Lance for ultra high pressure guns with extension ST-9. Max. 500 bar / 150 °C

R+M Nr.	☺	☻
200 000 231	1/4" F NPT	M22 M

Seal kit ST-3600



R+M Nr.
203 600 490

Symbols ☺ outlet ☻ inlet ☺ length

ST-2750 - the lightweight among the 500 bar spray guns

ST-2750



Professional ultra high pressure gun with patented LTF. Max. 500 bar / 30 l/min / 150 °C

R+M Nr.		
202 750 500	1/4" F	3/8" F



Professional ultra high pressure gun with patented LTF. Max. 500 bar / 30 l/min / 150 °C

R+M Nr.		
202 750 535	M22 F	M22 M



Professional ultra high pressure gun with patented LTF. Gun with insulated outlet suitable for lances with swivel screw coupling. Max. 500 bar / 30 l/min / 150 °C

R+M Nr.		
202 750 570	M22 M	M22 M



Professional ultra high pressure gun with extension ST-9.1 240 mm and quick screw coupling ST-740. Max. 500 bar / 30 l/min / 150 °C

R+M Nr.		
202 750 610	M24 F	3/8" F



ST-2750

R+M Nr.	
202 750 495	

Ultra high pressure lance



M24 M. Lance 400 mm with nozzle protector ST-10 without nozzle. Lance for ultra high pressure guns with extension ST-9.1. Max. 600 bar / 150 °C

R+M Nr.		
203 600 470	1/4" F NPT	M24 M

LTF - Low Trigger Force 90 % reduced holding force and 40 % reduced trigger force against usual market guns.

Shoulder supports

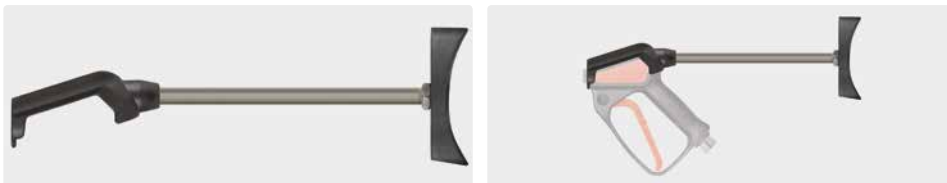

New European Union guidelines imperatively prescribe the use of shoulder supports for cleaning applications exceeding an operating reaction force of 150 N.

R+M Nr.	
202 705 590	

ST-350 swivel

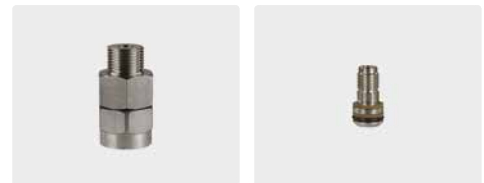

3/8" M : 3/8" F. Max. 500 bar

Repair kit ST-350

R+M Nr.	R+M Nr.
200 350 010	200 300 120

Suttner high pressure spray guns

ST-2000



Professional gun.
Max. 275 bar / 45 l/min / 150 °C

R+M Nr.		
202 000 500	1/4" F	3/8" F



Professional gun.
Max. 275 bar / 45 l/min / 150 °C

R+M Nr.		
202 000 590	1/4" F	3/8" F swivel

ST-300 swivel



1/4" F : 3/8" F. ST-2000

R+M Nr.
200 300 050



Repair kit ST-300

R+M Nr.
200 300 100

Valve complete



ST-2000

R+M Nr.
202 000 044

kommunal365+



Professional gun.
Max. 150 bar / 80 l/min / 150 °C

R+M Nr.		
202 320 500	1/4" F	1/2" F



Professional gun.
Max. 150 bar / 80 l/min / 150 °C

R+M Nr.		
202 320 510	1/2" F	1/2" F



Professional gun.
Max. 150 bar / 80 l/min / 150 °C

R+M Nr.		
202 320 520	1/2" F	1/2" F swivel

ST-340 swivel



1/4" F : 1/2" F

R+M Nr.
200 340 520



Repair kit ST-340

R+M Nr.
200 340 100

Seal kit



R+M Nr.
202 320 495

Shoulder support



New European Union guidelines imperatively prescribe the use of shoulder supports for cleaning applications exceeding an operating reaction force of 150 N.

R+M Nr.
202 705 590

Symbols outlet inlet

ST-3500 high-flow spray guns



Professional high-flow gun. Stainless steel. Industrial high pressure cleaning and jetting gun for municipal cleaning and other industrial cleaning tasks. Valve piston hardened stainless steel. Max. 350 bar / 200 l/min / 150 °C



Professional high-flow gun. Stainless steel. Industrial high pressure cleaning and jetting gun for municipal cleaning and other industrial cleaning tasks. Valve piston hardened stainless steel. Swivel stainless steel. Max. 350 bar / 200 l/min / 150 °C

Shoulder support ST-3900



ST-3900 shoulder supports. New European Union guidelines imperatively prescribe the use of shoulder supports for cleaning applications exceeding an operating reaction force of 150 N. Variably adjustable ST-3900. Swiveling coupling. Suitable for guns ST-3600 / ST-3500.

R+M Nr.	☉	☺
203 500 500	1/2" F	1/2" F

R+M Nr.	☉	☺
203 500 550	1/2" F	1/2" F swivel

R+M Nr.	telescope ☉	☺
203 900 500	340 - 500 mm	505 - 675 mm

Long Cast Nozzle

- » Stainless steel
- » Applications: cleaning of shafts
- » Extremely high impact force
- » Long reach
- » Nozzle protection
- » Max. 500 bar / 150 °C

R+M Nr.	☉	☺
040 001 963	5 mm	3/4" M

Industrial high-flow gun ST-3500, lance 500 mm with side handle. Long Cast Nozzle. Max. 350 bar / 200 l/min / 150 °C

Application:

- » Man hole cleaning
- » Paper Industry. Removal of snow balls during fibre jetting
- » Cleaning Tasks in Off-Shore or Marine Applications

R+M Nr.	☉	☺
203 500 560	750 mm	1/2" F swivel

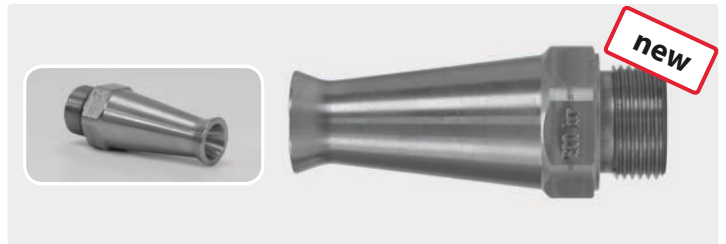

Longcast lances



3/8" F. Stainless steel. Longcast lance 300 mm with vented handle ST-29 Cool & Compact 330 mm, gun ST-2300, grip aside and nozzle protector made out of plastic without nozzle.
Max. 280 bar / 45 l/min / 100 °C

R+M Nr.		
200 078 510	nozzle protector without nozzle	3/8" F

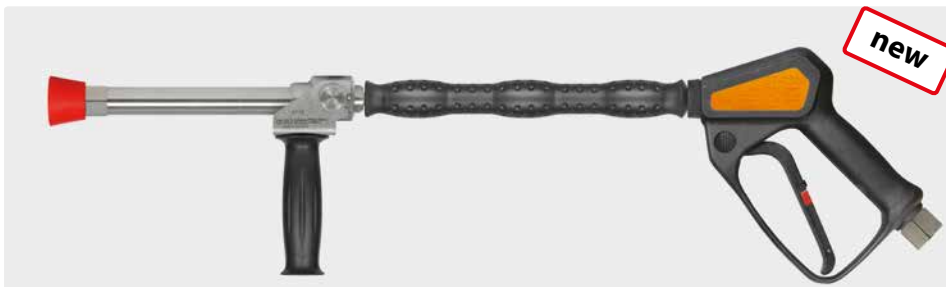

1/2" F. Stainless steel. Longcast lance 300 mm with vented handle ST-29 Cool & Compact 330 mm, gun ST-2320, grip aside and nozzle protector made out of plastic without nozzle.
Max. 150 bar / 80 l/min / 100 °C

R+M Nr.		
200 078 520	nozzle protector without nozzle	1/2" F



LTF

1/2" F. Stainless steel. Longcast lance 300 mm with vented handle ST-29 Cool & Compact 330 mm, gun easyfarm365+, grip aside and nozzle protector made out of plastic without nozzle.
Max. 250 bar / 60 l/min / 100 °C

R+M Nr.		
200 078 530	nozzle protector without nozzle	1/2" F swivel



1/4" M. Stainless steel. Longcast lance 300 mm with vented handle ST-29 Cool & Compact 330 mm, grip aside and nozzle protector made out of plastic without nozzle.
Max. 280 bar / 130 l/min / 100 °C

R+M Nr.		
200 078 500	nozzle protector without nozzle	1/4" M

The longcast lance can be connected to a low pressure pump, to a high pressure pump, to the public water system or to the extinguishing water network.

The lance works in the medium pressure range. By means of its very good solidity, good handling and compactness the lance is especially suitable for the intensive use.

The lateral hand grip makes a stepless adjustment of the water jet during the operation possible. A long casting point jet or a progressive, conical spray jet can be set.

In order to realize ideal cleaning results the nozzle size needs to be adapted to the pump performance (pressure and water quantity).

Nozzles for longcast lances

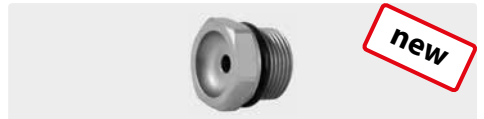

M15x1 M. Stainless steel

R+M Nr.	D
200 078 412	1.2 mm
200 078 415	1.5 mm
200 078 420	2.0 mm
200 078 423	2.3 mm
200 078 425	2.5 mm
200 078 430	3.0 mm
200 078 435	3.5 mm

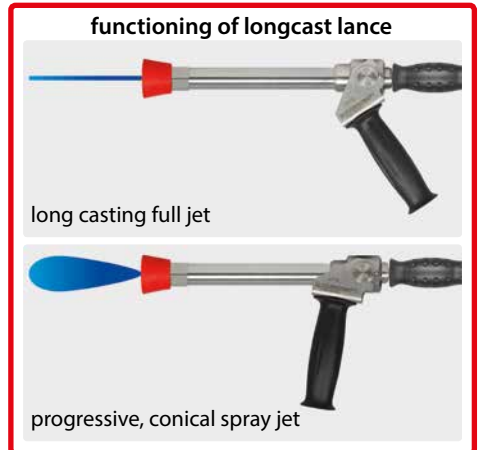

easywash365+ spray guns by Suttner

Freeze stop valves in **easywash365+** spray guns and freeze stop spray guns

Except for the valve screw the valves are completely made out of stainless steel. Contrary to all common freeze stop valves the real body is a hardened stainless steel ball. This difference significantly increases the robustness, reliability as well as preciseness in switching.

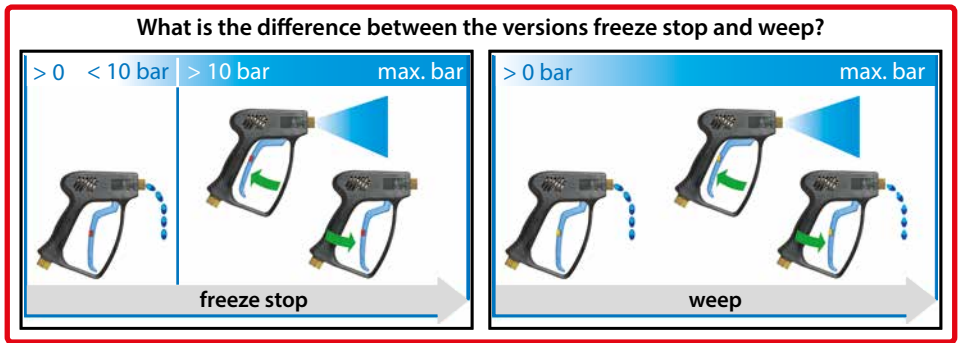

easywash365+ standard



LTF

Professional gun. Standard.
Max. 310 bar / 45 l/min / 150 °C

R+M Nr.		
202 600 518	1/4" F	3/8" F swivel

easywash365+ weep



LTF

Professional gun. Weep version.
Max. 310 bar / 45 l/min / 150 °C

R+M Nr.		
202 600 528	1/4" F	3/8" F swivel

easywash365+ freeze stop



LTF

Professional gun. Freeze stop version.
Max. 310 bar / 45 l/min / 150 °C

R+M Nr.		
202 600 538	1/4" F	3/8" F swivel

LTF - Low Trigger Force 90 % reduced holding force and 40 % reduced trigger force against usual market guns.

easywash365+ standard



LTF

Professional gun with lance swivel ST-345.
Standard. Max. 310 bar / 45 l/min / 150 °C

R+M Nr.		
202 600 802	1/4" F	3/8" F swivel

easywash365+ weep



LTF

Professional gun with lance swivel ST-345. Weep version. Max. 310 bar / 45 l/min / 150 °C

R+M Nr.		
202 600 803	1/4" F	3/8" F swivel

easywash365+ freeze stop



LTF

Professional gun with lance swivel ST-345. Freeze stop version. Max. 310 bar / 45 l/min / 150 °C

R+M Nr.		
202 600 804	1/4" F	3/8" F swivel

Valves complete - easywash365+



Standard

R+M Nr.
202 300 490



Weep

R+M Nr.
202 300 491



Freeze stop

R+M Nr.
202 300 457

ST-301 swivel - easywash365+



1/4" F : 3/8" F

R+M Nr.
200 301 050



Repair kit ST-301

R+M Nr.
200 300 100

Suttner high pressure spray guns for self-service car wash

ST-1100 weep





Professional gun. Weep version.
Max. 210 bar / 25 l/min / 150 °C

R+M Nr.		
201 100 535	1/4" F	3/8" F

ST-1100 weep



Professional gun. Weep version.
Max. 210 bar / 25 l/min / 150 °C

R+M Nr.		
201 100 530	1/4" F	3/8" F swivel

ST-1100 without trigger



Professional gun without valve.
Max. 210 bar / 25 l/min / 150 °C

R+M Nr.		
201 100 570	1/4" F	3/8" F swivel

ST-1100



Repair kit swivel

R+M Nr.
200 300 100

ST-2300 freeze stop



Professional gun. Freeze stop version.
Max. 310 bar / 45 l/min / 150 °C

R+M Nr.		
202 300 582	1/4" F	3/8" F swivel

ST-2300 weep



Professional gun. Weep version.
Max. 310 bar / 45 l/min / 150 °C

R+M Nr.		
202 300 580	1/4" F	3/8" F

ST-2300 weep



Professional gun. Weep version.
Max. 310 bar / 45 l/min / 150 °C

R+M Nr.		
202 300 581	1/4" F	3/8" F swivel

ST-2600 freeze stop



LTF

Professional gun with patented LTF technology.
Max. 310 bar / 45 l/min / 150 °C

R+M Nr.		
202 600 536	1/4" F	3/8" F swivel

ST-2600 weep



LTF

Professional gun with patented LTF technology.
Max. 310 bar / 45 l/min / 150 °C

R+M Nr.		
202 600 544	1/4" F	3/8" F swivel

Symbols  outlet  inlet

Suttner high pressure spray guns

ST-601 linear standard



Standard.
Max. 275 bar / 45 l/min / 150 °C

R+M Nr.		
200 601 600	1/4" F	3/8" F

ST-601 linear freeze stop



Freeze stop version.
Max. 275 bar / 45 l/min / 150 °C

R+M Nr.		
200 601 601	1/4" F	3/8" F

ST-601 linear weep



Weep version.
Max. 275 bar / 45 l/min / 150 °C

R+M Nr.		
200 601 602	1/4" F	3/8" F

Valve complete

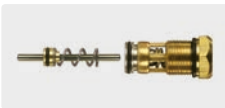

ST-601

R+M Nr.
202 000 044

ST-1500 freeze stop



Professional gun. Freeze stop version.
Max. 275 bar / 45 l/min / 150 °C

R+M Nr.		
201 500 580	1/4" F	3/8" F

ST-1500 freeze stop



Professional gun. Freeze stop version.
Max. 275 bar / 45 l/min / 150 °C

R+M Nr.		
201 500 581	1/4" F	3/8" F swivel

ST-1500 weep



Professional gun. Weep version.
Max. 275 bar / 45 l/min / 150 °C

R+M Nr.		
201 500 620	1/4" F	3/8" F

ST-1500 without trigger



Professional gun without trigger.
Max. 275 bar / 45 l/min / 150 °C

R+M Nr.		
201 500 750	1/4" F	3/8" F

Valves



ST-2300. Freeze stop

R+M Nr.
202 300 457



ST-2300. Weep

R+M Nr.
202 300 491



ST-1500. Freeze stop

R+M Nr.
202 000 101



ST-1500. Weep

R+M Nr.
202 000 045

ST-301 swivel



1/4" F : 3/8" F. ST-2300

R+M Nr.
200 301 050

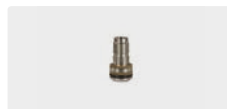

Repair kit ST-301

R+M Nr.
200 300 100

ST-300 swivel



1/4" F : 3/8" F. ST-1500

R+M Nr.
200 300 050

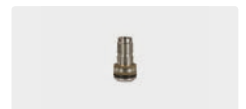

Repair kit ST-300

R+M Nr.
200 300 100

Symbols outlet inlet

easywash365+ handles by Suttner



Stainless steel. Handle 20° bended.
Max. 350 bar / 150 °C

R+M Nr.		
200 009 650	1/4" F	1/4" M



Stainless steel. Handle 20° bended.
easywash365+ blue. Max. 350 bar / 150 °C

R+M Nr.		
200 009 655	1/4" F	1/4" M



Stainless steel. Handle 20° bended.
Max. 350 bar / 150 °C

R+M Nr.		
200 009 665	1/4" F	1/4" M



Stainless steel. Handle 20° bended.
Max. 350 bar / 150 °C

R+M Nr.		
200 009 657	1/4" F	M18 M (CEL)



Stainless steel. Handle 20° bended.
Max. 350 bar / 150 °C

R+M Nr.		
200 009 659	M18 F (DKOL)	M18 M (CEL)



Stainless steel. Retrofit kit. M18 F (DKOL) : 1/4" M

R+M Nr.		
200 009 480		

easywash365+ lance swivels ST-345 by Suttner

The **easywash365+** lance swivel guarantees improved ergonomics in the professional car wash and in the cleaning industry. The lance swivel is mounted between the brush lance or spray lance and the high pressure gun or the brush grip.



1/4" F : 1/4" M. 350 bar. Stainless.
RAL 5005

R+M Nr.
200 345 520



1/4" F : 1/4" M. 350 bar. Stainless

R+M Nr.
200 345 530



1/4" F : 1/4" M. 350 bar. Stainless

R+M Nr.
200 345 500



1/4" F : 1/4" M. 350 bar. Stainless.
easywash365+ blue

R+M Nr.
200 345 510

Low pressure pre-spraying unit



Hose flexy



Pre-spraying unit with gun ST-810, lance ST-28 Cool & Compact zinc-plated steel, nozzle protector ST-10 and nozzle 65° 01 with filter. Max. 140 bar / 150 °C

R+M Nr.				R+M Nr.
200 810 785	nozzle 65° 01	500 mm	1/4" M swivel	390 052 208

High pressure spray guns

RL22

SPECK star



Max. 310 bar / 40 l/min / 160 °C

R+M Nr.		
500 522 00	1/4" F	3/8" F



Max. 310 bar / 40 l/min / 160 °C

R+M Nr.		
500 522 01	1/4" F	3/8" F swivel



Max. 280 bar / 40 l/min / 150 °C

R+M Nr.		
506 00	1/4" F	3/8" F

ST-550 foot valves



Housing stainless steel. Valve stainless steel. Rubber feet.
Max. 500 bar / 80 l/min / 150 °C

R+M Nr.		
200 550 600	1/4" F	1/4" F



Housing stainless steel. Valve stainless steel. Rubber feet.
Max. 500 bar / 80 l/min / 150 °C

R+M Nr.		
200 550 620	M22 F	M22 M

ST-540 foot valves

new



Incl. HP-gun ST-2605. Material housing powdercoated steel. Rubber feet.
Max. 350 bar / 45 l/min / 150 °C

R+M Nr.		
200 540 500	1/4" M	3/8" F



Incl. HP-gun ST-2750. Material housing powdercoated steel. Rubber feet.
Max. 500 bar / 30 l/min / 150 °C

R+M Nr.		
200 540 550	1/4" M	3/8" F

Symbols outlet inlet length

Half-shell kits: Makeover of your gun



With effect from today, we enlarge the range of colours for our gun family ST-2300, ST-2600, and ST-2700. You can choose from green, blue, red, and yellow!

By means of our half-shell kits, it is possible to adapt the guns individually to your company's colour or to the one of your customers. By using different colours, the affiliation to a certain unit (e.g. rental business), user, or application is possible in an easy way, too.

Moreover, the guns can be used for allocation to different areas within the scope of the HACCP directive. In this respect, we offer further interesting products in different colours for lance clips, nozzle protectors, and plugs for rotating nozzles in Chapter 13, HACCP. This product range now features coloured insulated handles for lances with a length of 900 mm.

What would you like to mark in your colour? Select your appropriate half-shell kit, here!

If you like to have your corporate logo on the logo plate, please follow the instructions given on the following page: "Design your own Suttner gun".

Kit contains half shells, logo plate, trigger and trigger lock



R+M Nr.
202 300 473



R+M Nr.
202 300 474



R+M Nr.
202 300 471



R+M Nr.
202 300 472

Create your individual Suttner spray gun

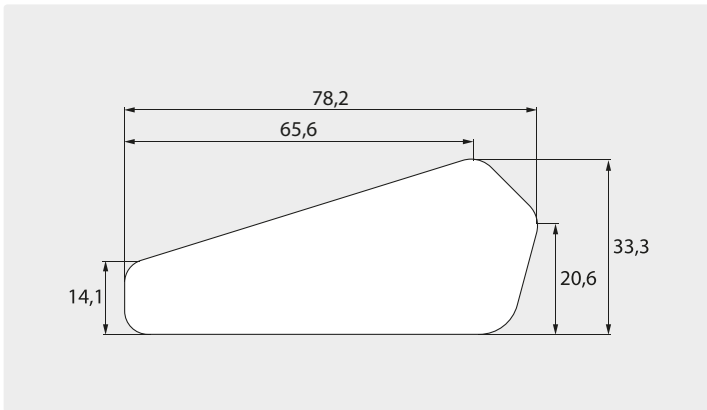

If you are honest with yourselves, will you not appreciate seeing your company's logo on your Suttner spray gun? Or do you prefer having the telephone number of your favourite restaurant or the web site of your football team on your spray gun? It's up to you. We will certainly let your dream come true.

In the following passage we show you how that works. These seven steps have to be made:

Step 1 choose your model: ST-2300 or ST-2600

Step 2 determine your desired version

Step 3 state your favourite colour

Step 4 fill in the file with the label and return it to R+M. Please provide us your logo in one of the most common kinds of file (BMP, FES, GIF) and inform us about the typeface and typesize which you have used

Step 5 release the processed logo in writing

Step 6 arrange for a one-time transfer of € 300.00 for the production of the tools needed for the label

Step 7 place an order with us for 250 labels and one packing unit of spray guns (35 or 50 guns) without label

R+M Nr.	TYP	⊖	⊕	VPE
202 600 501	ST-2600	1/4" F	3/8" F	50
202 600 549	ST-2600	coupling KW	3/8" F swivel	35
202 600 557	ST-2600	1/4" F	3/8" F swivel	50

R+M Nr.	TYP	⊖	⊕	VPE
202 300 501	ST-2300	1/4" F	3/8" F	50
202 300 521	ST-2300	1/4" F	M 22 M	50
202 300 551	ST-2300	1/4" F	3/8" F swivel	50
202 300 562	ST-2300	coupling KW	3/8" F	35
202 300 571	ST-2300	coupling KW	3/8" F swivel	35

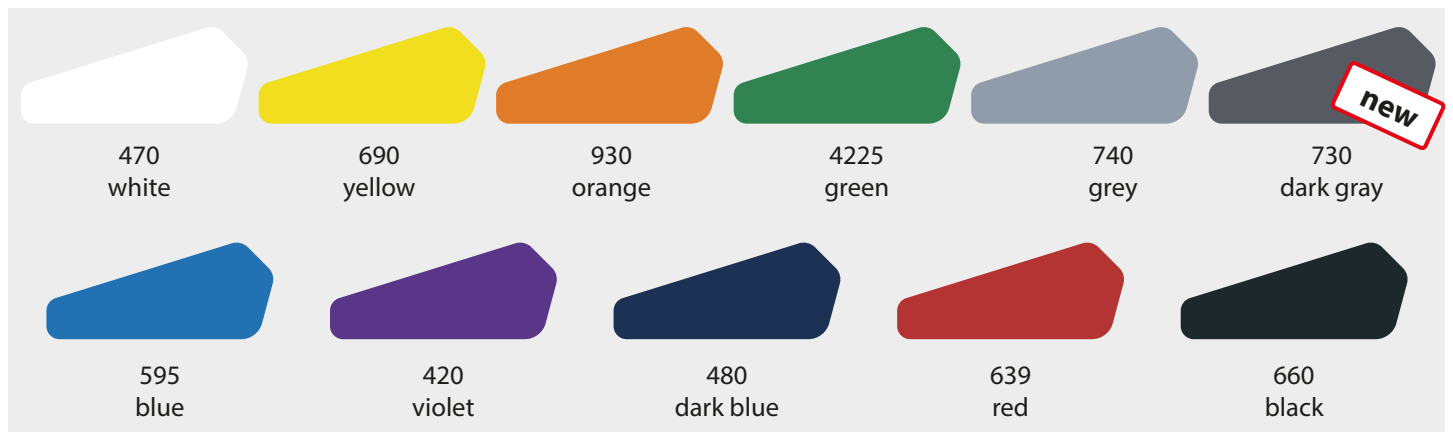

Create your individual Suttner vented handle

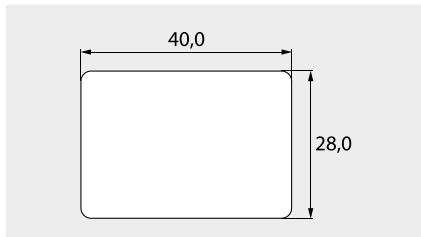

R+M Nr.		
200 009 051	380 mm	max. 150 °C

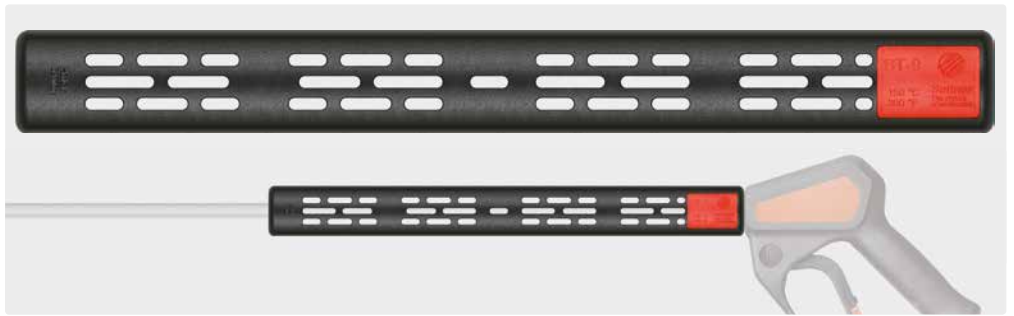

With effect from today we offer you the possibility to combine your personal spray guns ST-2300 and ST-2600 with your individual vented handle ST-9. It is suitable for all 1/4" lances and if required, a grip can be mounted on the side at any time. Furthermore, the vented handle can be pushed over the outlet of all Suttner spray guns so that both products form an aesthetic whole. In case of hot water applications the user is steadily protected.

Try to determine your favourite colour of your personal label and already start thinking about what you would like to have written on it or which emblem you would like to see on it. It is really up to you as you can give free rein to your creativity. We will certainly let your dream come true. By means of labelling your personal ST-9 you succeed in enhancing the product itself and also in making your company and brand better known.

Get to your personal vented handle ST-9 in only 5 steps!

- Step 1 determine your favourite colour
- Step 2 fill in the file with the label and return it to R+M. Please provide us your logo in one of the most common kinds of files (BMP, FES, GIF) and inform us about the typeface and type size which you have used
- Step 3 release the processed label in writing
- Step 4 arrange for a one-time transfer of € 300.00 for the production of the tools needed for the label
- Step 5 place an order with us for 240 labels and 1 packing unit of vented handles (80 pieces, R+M Nr. 200 009 051) without label



Symbols outlet inlet VPE packing unit TYP type length temperature

Gun exit connections

Connections for spray guns with coupling KW



Plug KW : 1/4" F. Stainless steel. SW 17. For lances with vented handle

R+M Nr.
160 187 1



Plug KW : 1/4" F. Stainless steel. SW 19. Plug for moulded handles

R+M Nr.
040 001 255

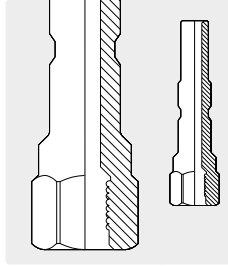

Plug KW : 1/4" F. SW 19. Polished stainless steel. For moulded handles. Plug for aluminium washer

R+M Nr.
040 001 248

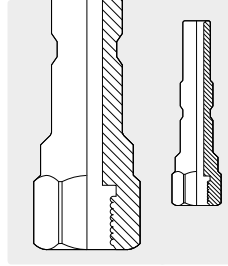

Aluminium washer for 1/4" F. \varnothing 11 mm

R+M Nr.	VPE
781 130 841	100



Plug KW : M21 M. stainless steel. Brass. Lances with quick screw coupling

R+M Nr.
559 101



Plug KW : M22 M. stainless steel. Brass. Lances with quick screw coupling

R+M Nr.
559 103



Plug KW : plug ST-45. stainless steel. Zinc-plated steel

R+M Nr.
559 102



Plug KW : M22 F. stainless steel. Brass

R+M Nr.
559 104



Plug KW : 1/4" M. stainless steel

R+M Nr.
040 001 256

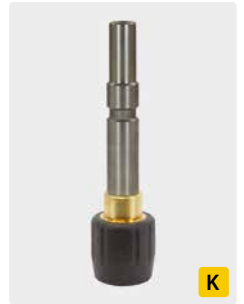

Nozzle protector with plug KW. Without tip. Max. 400 bar / 150 °C

R+M Nr.
559 105

Coupling KW for spray guns

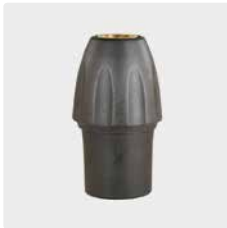

Coupling KW : 1/4" M. Brass

R+M Nr.
559 26

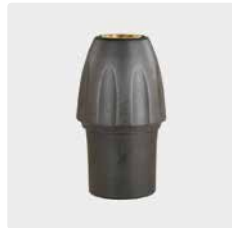

Coupling KW : 1/4" M. Stainless steel

R+M Nr.
202 700 350



Coupling KW : 1/4" M. Stainless steel

R+M Nr.
202 700 355



Coupling KW : M21 F. Brass

R+M Nr.
559 261



Coupling KW : M22 F. Brass

R+M Nr.
559 262



Coupling KW : M22 M. Brass

R+M Nr.
559 263



Coupling KW : M22 F. Brass

R+M Nr.
202 300 488

Bajonet adapter



1/4" F

R+M Nr.
200 000 440



M22 F long

R+M Nr.
559 980 500



HV M22 short

R+M Nr.
559 980 505

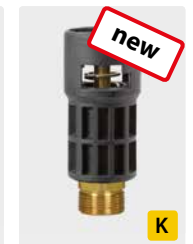

M22 M

R+M Nr.
559 980 510

O-ring



O-ring for coupling KW

R+M Nr.
050 000 248

Lip seals



Tool for assembly of lip seal

R+M Nr.
202 300 365



Lip seal for coupling KW

R+M Nr.
050 000 249

Half lance exit connections

Connections for hobby half lances

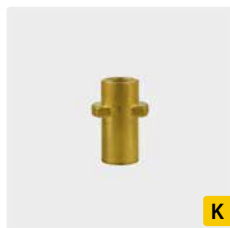

Plug K : 1/4" F

R+M Nr.
200 000 435

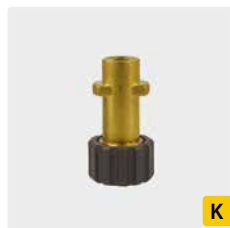

Plug K : M22 F

R+M Nr.
559 93

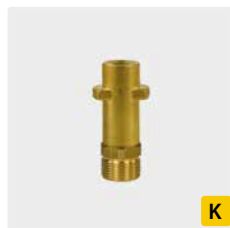

Plug K : M22 M

R+M Nr.
559 94

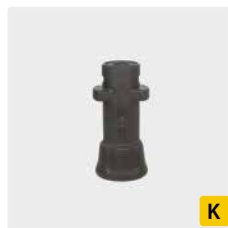

Plug K : 1/4" F. Plastic with brass thread

R+M Nr.
200 000 436

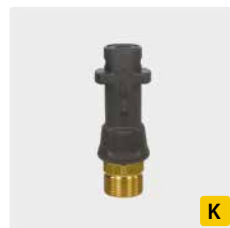

Plug K : M22 M. Plastic with brass thread

R+M Nr.
559 95

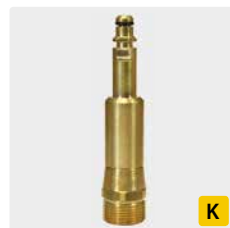

Plug 8.8 : M22 M. Brass. Max. 250 bar / 100 °C

R+M Nr.
559 908 221

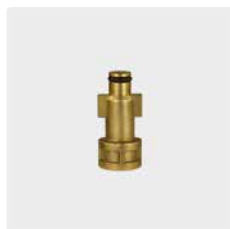

Plug Aqua : 1/4" F

R+M Nr.
559 21



Plug KW : 1/4" F

R+M Nr.
559 20

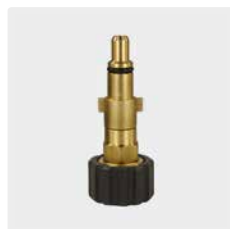

Plug KW : M22 F

R+M Nr.
559 201

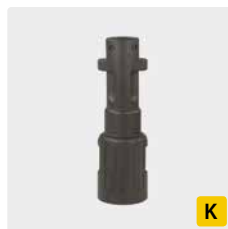

Plug K : bayonet KW

R+M Nr.
559 55



M22 M : bayonet KW

R+M Nr.
559 56



Plug : 1/4" F. Suitable for Annovi

R+M Nr.
200 000 438



Bayonet KW suitable for Lavor, Annovi & Alto

R+M Nr.
559 58



Bayonet KW suitable for Faip & Aqua

R+M Nr.
559 59



Plug Pro : 1/4" F

R+M Nr.
200 000 439

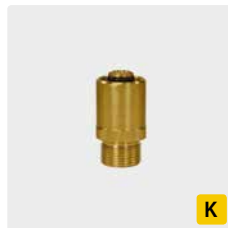

M22 F : M22 M. Suitable for Servopress

R+M Nr.
565 67

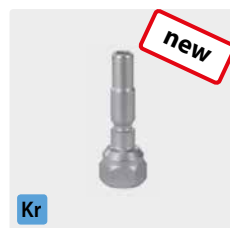

Plug KR-Hobby : 1/4" F. Stainless steel. HEX 19.

R+M Nr.	⌀
040 001 209	9.5

Wall mount



Stainless steel. Wall mount for Suttner high pressure spray guns with lance or twin lance

R+M Nr.
040 002 055



Symbols ⌀ diameter VPE packing unit

Gun extensions



1/4" M. Lance with insulation ST-28 Cool & Compact. Max. 400 bar / 150 °C

R+M Nr.		ISO		M
200 028 303	1/4" M	300 mm	330 mm	zinc-plated steel



1/4" M. Lance with insulation ST-29 Cool & Compact. Max. 400 bar / 150 °C

R+M Nr.		ISO		M
200 029 303	1/4" M	300 mm	330 mm	stainless steel



1/4" M. Lance with insulation ST-9.1 and M22 F. Max. 400 bar / 150 °C

R+M Nr.		ISO		M
200 009 730	M22 F		350 mm	stainless steel
200 009 731	M22 F		350 mm	zinc-plated steel



1/4" M. Lance with insulation ST-9.1 and coupling KW. Max. 400 bar / 150 °C

R+M Nr.		ISO		M
200 009 750	coupling KW		260 mm	stainless steel



1/4" M. Lance with insulation and M22 F. Max. 400 bar / 150 °C

R+M Nr.		ISO		M
202 300 400	M22 F		340 mm	zinc-plated steel



1/4" M. Lance with insulation ST-9.9 and M22 F. Max. 400 bar / 150 °C

R+M Nr.		ISO		M
200 009 945	M22 F		370 mm	zinc-plated steel



1/4" M. Lance with insulation ST-9.9 and M22 F. Max. 400 bar / 150 °C

R+M Nr.		ISO		M
200 009 940	M22 F		370 mm	zinc-plated steel



1/4" M. Lance with moulded handle. Max. 400 bar / 150 °C

R+M Nr.		ISO		M
070 004 340	1/4" M	400 mm	440 mm	stainless steel



1/4" M. Lance with moulded handle. Max. 400 bar / 150 °C

R+M Nr.		ISO		M
070 000 330	1/4" M	300 mm	330 mm	zinc-plated steel
070 000 240	1/4" M	400 mm	440 mm	zinc-plated steel



1/4" M. Lance with moulded handle. Max. 400 bar / 150 °C

R+M Nr.		ISO		M
070 003 229	1/4" M	300 mm	330 mm	stainless steel

Symbols outlet ISO insulation length M material

Gun extensions with handle

new

1/4" M. Lance with handle and insulation ST-28.2/ST-29.2 Cool & Compact. Max. 400 bar / 150 °C



R+M Nr.	⊖	ISO	⊖	M
200 028 204	1/4" M	400 mm	430 mm	zinc-plated
200 029 204	1/4" M	400 mm	430 mm	stainless steel



R+M Nr.	⊖	ISO	⊖	M
200 028 210	1/4" M	400 mm	1,000 mm	zinc-plated
200 029 210	1/4" M	400 mm	1,000 mm	stainless steel

Insulations for lances

Insulations ST-9.9



Insulation 330 mm. Suitable for 1/4" lances. Max. 150 °C

R+M Nr.
200 009 935



Insulation 330 mm. Suitable for 1/4" lances. Max. 150 °C

R+M Nr.
200 009 936

Vented handles ST-9



Vented handle 380 mm. Suitable for 1/4" lances. Max. 150 °C

R+M Nr.
200 009 510

Adapter for lances



M18 M : TR20 F. K-Lock 8. Brass.
Max. 400 bar / 150° C

new

K

R+M Nr.
565 686

